

4/3 Proportional Control Valve, Screw-in Cartridge design

SD2P-B4

7/8-14 UNF • Q_{max} 25 l/min (7 GPM) • p_{max} 250 bar (3630 PSI)

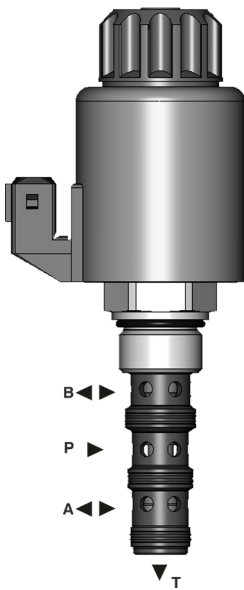

Technical Features

- › Proportional valve with integrated hydraulic lock control function
- › Hardened and precision working parts
- › 12 and 24 VDC standard supply voltage of coils
- › Optional type of electrical terminal EN175301-803-A, AMP Junior Timer or Deutsch DT04-2P
- › Optional Built-in quenching diode for protection of electronic control unit
- › Economical design
- › Connector positioning thanks to coil rotation around its axes 360°
- › In the standard configuration steel parts are zinc coated for 240 h protection in NSS acc. to ISO 9227

Functional Description

The SD2P-B4 valve can be used in any application when it comes to routing hydraulic fluid to and from the consumer. Typically, these are applications that require lifting or lowering of a load. Thanks to the proportional adjustability of the valve, the motion speed can be adjusted to the given demands.

Compared to other available proportional 4/3 directional valves, the SD2P-B4 valve is equipped with only one solenoid for both actuation directions (usually two solenoids are needed). This design provides several benefits (e.g. more compact design, fewer electric connectors);

The SD2P-B4 is typically used in combination with a pilot-to-open check valve. The corresponding schematic is shown in Fig A, B and C. In such circuits, the check valve serves to decouple the consumer from the rest of the hydraulic system with zero leakage. The check valve is closed as long as the proportional valve is in center position / de-energized (Fig. A). Fig. B and C show how the energized switching positions facilitate „lowering“ and „lifting“ functions.

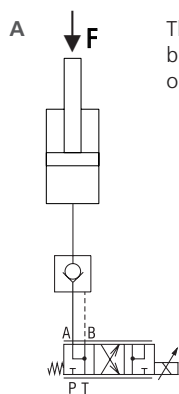

The piston lowering is blocked by closed pilot operated check valve.

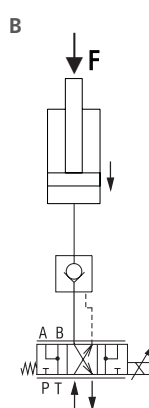

The pilot operated check valve is opened by pressure fluid in B channel and the cylinder is relieved to the tank via A channel – the piston moves downwards by acting load F; the lowering speed can be smoothly regulated by flow throttling on the spool adage.

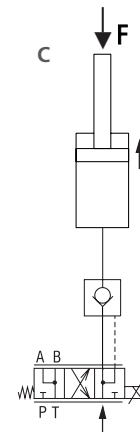

The pilot operated check valve remains open by fluid pressure in B channel. The pressure fluid is simultaneously led to the cylinder and the piston moves upwards. The lifting speed can be smoothly regulated.

Note:

The specific placement of the spool edge and the specific function of the Proportional directional control valve are protected by US patent 9,505,288 B2 a EP 2772373.

This original technical solution is the intellectual property of Fluid Systems Partners Holding AG and is subject to legal protection.

Technical Data

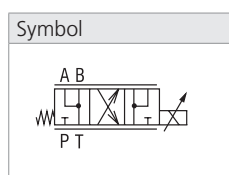

Valve size / Cartridge cavity		7/8-14 UNF-2A / B4	
Flow stages [$\Delta p = 10$ bar (145 PSI)]	l/min (GPM)	4 (1.1)	20 (5.3)
Max. flow	l/min (GPM)	9 (2.4)	25 (7)
Max. operating pressure	bar (PSI)	250 (3630)	
Max. proof pressure in T channel	bar (PSI)	100 (1450) T channel should stay without pressure for the correct function	
Fluid temperature range	°C (°F)	-30 ...90 (-22 ...194), +100 (212) short time	
Ambient temperature range	°C (°F)	-30 ...90 (-22 ...194), +100 (212) short time	
Response time at 100 % signal	ms	< 50	
Solenoid data			
Nominal supply voltage	V	12 DC	24 DC
Max. current	A	1.5	1
Rated resistance at 20 °C (68 °F)	Ω	5	13.4
Duty cycle	%	100	
Optimal PWM frequency	Hz	200	
Enclosure type acc.to EN 60529**		(acc.to terminal type) IP67 / IP69K	
Weight with solenoid	kg (lbs)	0.67 (1.48)	
	Data Sheet	Type	
General information		GI_0060	Products and operating conditions
Coil types		C_8007	C22B*
Valve bodies	In-line mounted	SB_0018	SB-B4*
	Sandwich mounted	SB-04(06)_0028	SB-*B4*
Cavity details / Form tools		SMT_0019	SMT-B4*
Spare parts		SP_8010	

**The indicated IP protection level is only reached with a properly mounted connector.

Ordering Code

SD2P-B4 / H [] - [] - [] [] [] [] - []

4/3 proportional directional control valve with connecting thread 7/8-14 UNF

Valve cavity 7/8-14 UNF-2A

Model High performance

Functional symbol



3Y13

Nominal flow rate P → A at Δp = 10 bar (1450 PSI)
 4 l/min (1.1 GPM)
 20 l/min (5.3 GPM)

5
25

Surface treatment
A zinc-coated (ZnCr-3), ISO 9227 (240 h)
B zinc-coated (ZnNi), ISO 9227 (520 h)

Seals
 No designation NBR
V FPM (Viton)

Manual override
 No designation standard

Connector
E1 EN 175301-803-A
E2 E1 with quenching diode
E3A AMP Junior Timer - axial direction (2 pins; male)
E4A E3A with quenching diode
E12A Deutsch DT04-2P - axial direction (2 pins; male)
E13A E12A with quenching diode

Nominal supply voltage / max. current
 12 V DC / 1.5 A
 24 V DC / 1.0 A

Characteristics measured at v = 32 mm²/s (156 SUS)

Timing control limit SD2P-B4/H3Y13-5

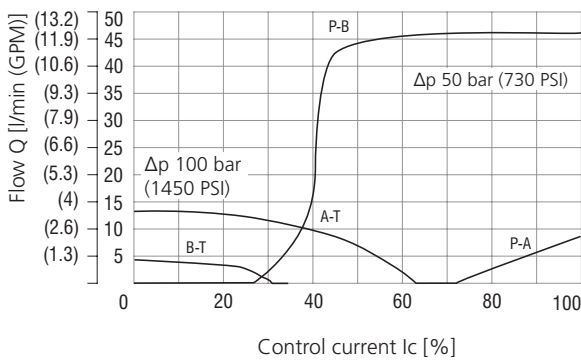

Timing control limit SD2P-B4/H3Y13-25

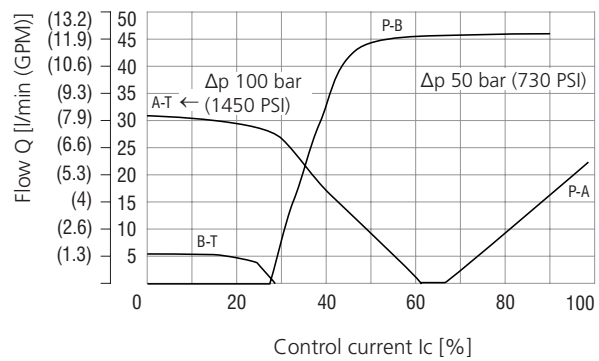

Operating limits SD2P-B4/H3Y13-5

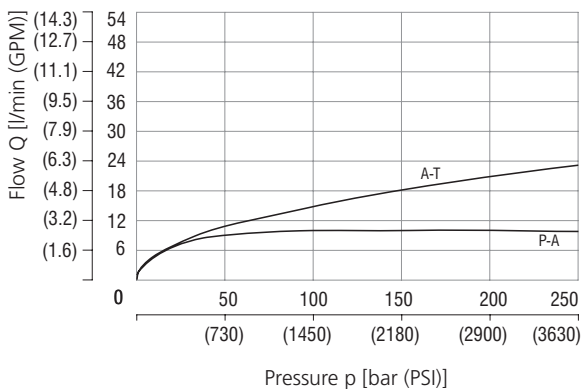

Operating limits SD2P-B4/H3Y13-25

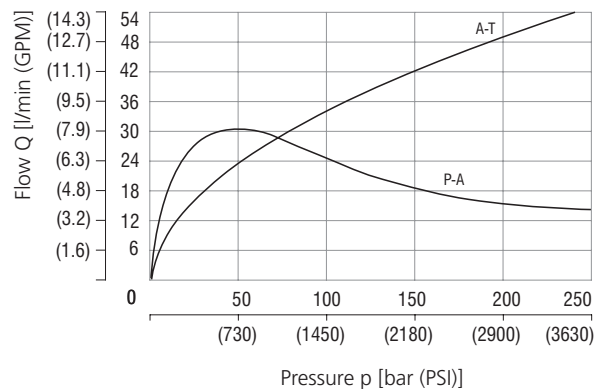

Pressure drop SD2P-B4/H3Y13-5

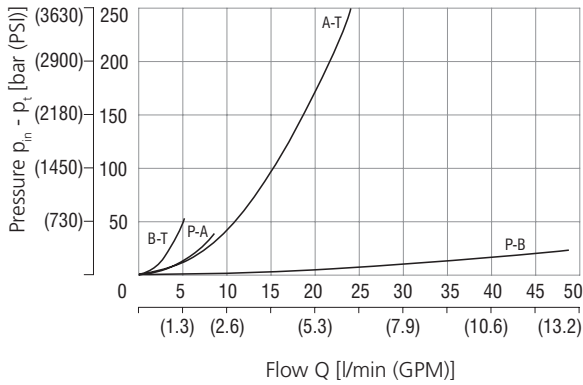

Pressure drop SD2P-B4/H3Y13-25

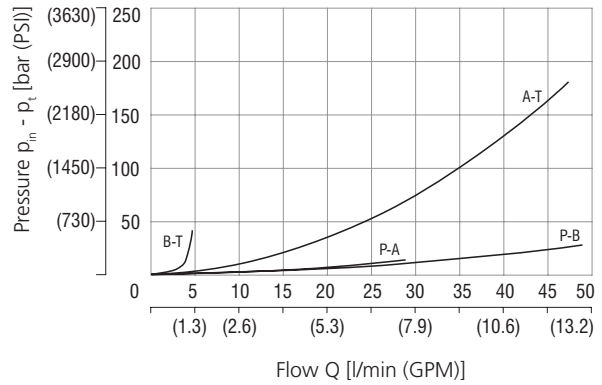

Flow characteristic SD2P-B4/H3Y13-5

Flow rate P - A

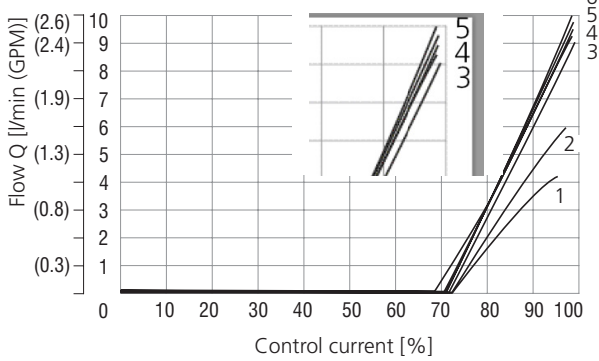

- 1 = Δp 10 bar (145 PSI)
- 2 = p_m 20 bar (290 PSI)
- 3 = p_m 50 bar (725 PSI)
- 4 = p_m 100 bar (1450 PSI)
- 5 = p_m 150 bar (2180 PSI)
- 6 = p_m 200 bar (2900 PSI)
- 7 = p_m 250 bar (3630 PSI)

Flow characteristic SD2P-B4/H3Y13-25

Flow rate P - A

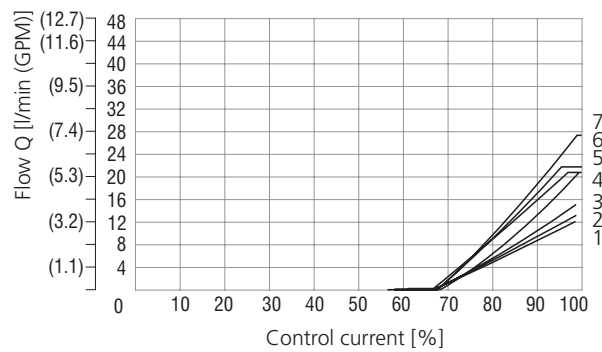

- 1 = p_m 250 bar (3630 PSI)
- 2 = p_m 200 bar (2900 PSI)
- 3 = p_m 150 bar (2180 PSI)
- 4 = p_m 100 bar (1450 PSI)
- 5 = Δp 10 bar (145 PSI)
- 6 = p_m 20 bar (290 PSI)
- 7 = p_m 50 bar (725 PSI)

Flow characteristic SD2P-B4/H3Y13-5

Flow rate A - T

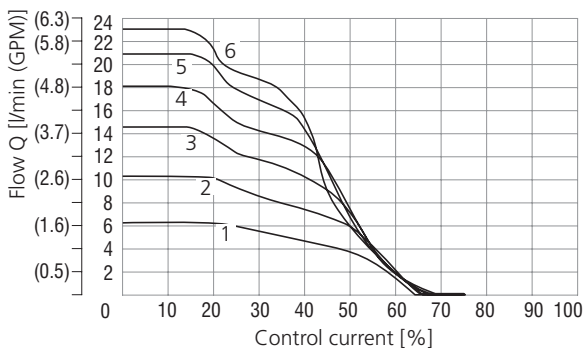

- 1 = p_m 20 bar (290 PSI)
- 2 = p_m 50 bar (725 PSI)
- 3 = p_m 100 bar (1450 PSI)
- 4 = p_m 150 bar (2180 PSI)
- 5 = p_m 200 bar (2900 PSI)
- 6 = p_m 250 bar (3630 PSI)

Flow characteristic SD2P-B4/H3Y13-25

Flow rate A - T

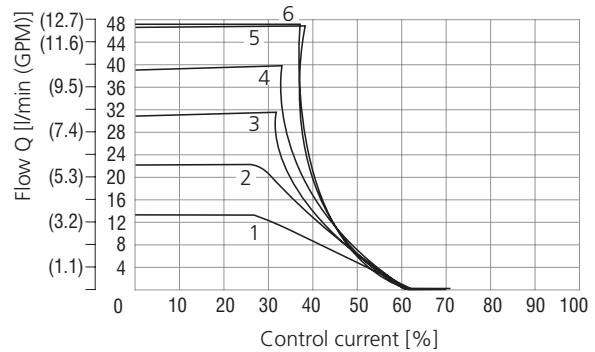

- 1 = p_m 20 bar (290 PSI)
- 2 = p_m 50 bar (725 PSI)
- 3 = p_m 100 bar (1450 PSI)
- 4 = p_m 150 bar (2180 PSI)
- 5 = p_m 200 bar (2900 PSI)
- 6 = p_m 250 bar (3630 PSI)

Dimensions in millimeters (inches)

Connector type

E3A, E4A - IP67 (AMP Junior Timer - axial direction)

E1, E2 - IP65
EN 175301-803-A

E12A, E13A - IP67/ IP69K
Deutsch DT04-2P

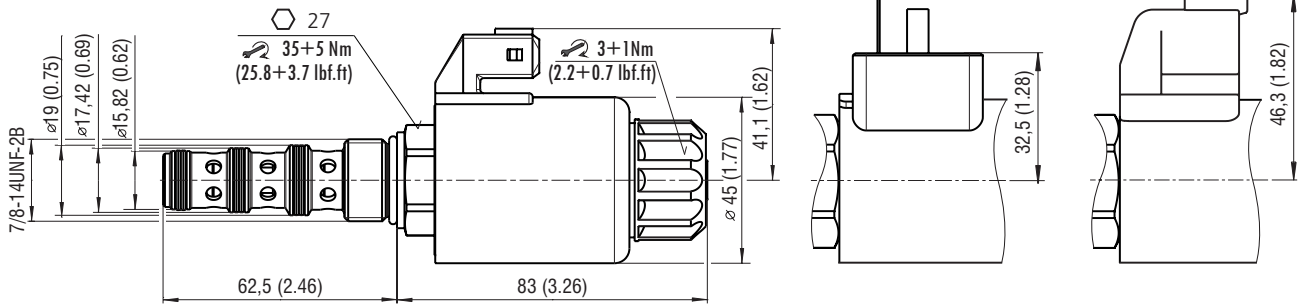

Manual Override in millimeters (inches)

No Designation - Standard

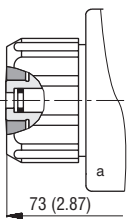

In case of solenoid malfunction or power failure, the spool of the valve can be shifted by manual override as long as the pressure in port T does not exceed 25 bar (363 PSI). For alternative manual overrides contact our technical support.